



WE PROVIDE THE BEST  
**PLASTICS**  
SOLUTIONS



**ON  
SCHEDULE  
DELIVERY**



**CUSTOMISED  
SOLUTIONS**



**ETHICAL  
BUSINESS  
PRACTICES**



**SKILLED  
PROFESSI-  
ONALS**



**FLAWLESS  
QUALITY**

WE PROVIDE THE BEST  
**PLASTICS**  
SOLUTIONS



## INTRODUCTION

Established in 2013, VIP Plastics is engaged in manufacturing, exporting and wholesaling of Plastic material handling Crates, Fruit and Vegetable crates, Industrial Crates, Dairy Crates, Planters, Plastic Pallets, Industrial Air Coolers etc. Under the firm direction of our mentor Mr. Vipul Kapoor, we are operating our company in a progressive and productive manner. His unique and successful marketing strategies and deep knowledge have made us able to cater huge clients.

### OUR MISSION

Our mission is assure that we provide best quality plastic solutions to our customers within best prices. Our company thrives to assure complete customer satisfaction for a long term business relation.

### OUR VISION

We at VIP plastics aim to bring the best injection molding technology to India, so that we are able to provide the best quality products at the most competitive prices globally.





Dairy



Fishery

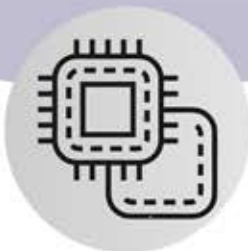

Electronic



Ice cream



Footwear



Liquor and wine



Textile



Automobile



Hardware



Bakery

& Many More..





# Crates

Fruits & Vegetables  
400 Series



- MODEL NO : 4032250
- WEIGHT : 1.1kg
- O.DIMENSION :

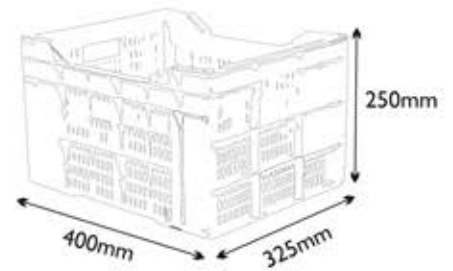

I.DIMENSION :  
365mm x 290mm x 245mm

- MODEL NO : 4032250
- WEIGHT : 1.15 kg
- O.DIMENSION :

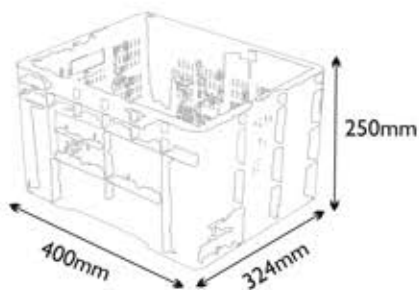

I.DIMENSION :  
365mm x 290mm x 245mm



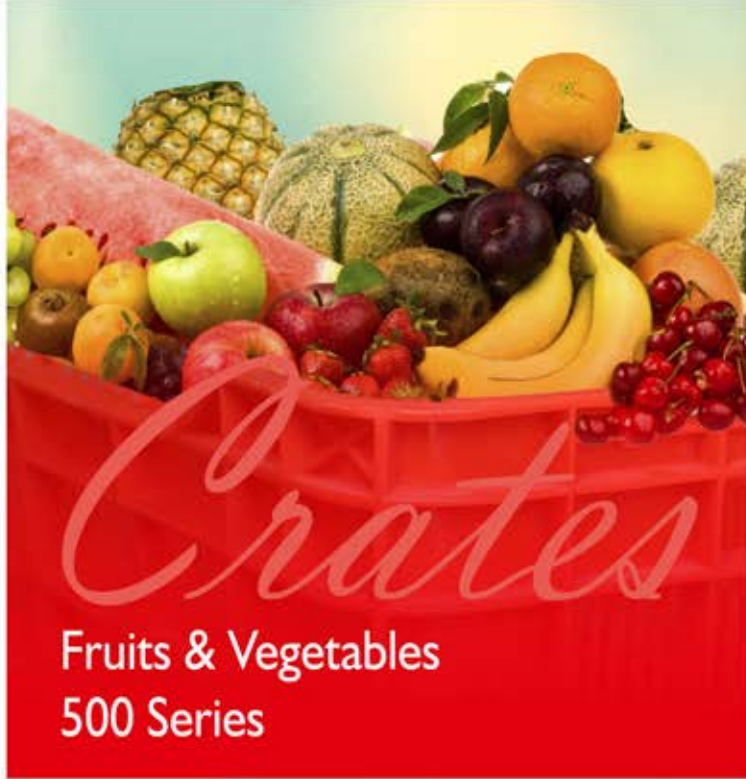

MODEL NO : 5435290

WEIGHT : 1.3 kg

O.DIMENSION :

I.DIMENSION :

510mm x 328mm x 280mm

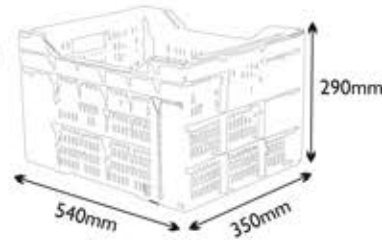

MODEL NO : 5435290

WEIGHT : 1.4 kg  
AVAILABLE IN 1.4 kg, 1.5 kg,  
1.65 kg, 1.85 kg, 2.0 kg

O.DIMENSION :

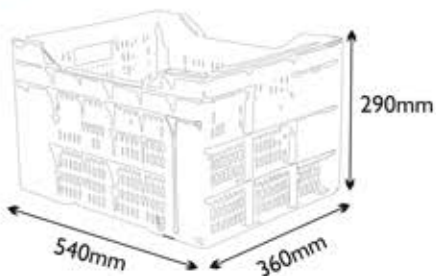

I.DIMENSION :

510mm x 328mm x 280mm

MODEL NO : 5436300

DAALA CRATE

WEIGHT : 1.85 kg

O.DIMENSION :

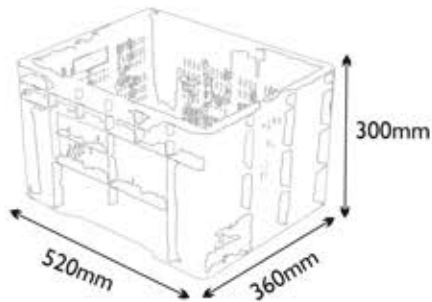

I.DIMENSION :

480mm x 325mm x 290mm

MODEL NO : 5439345

BANANA CRATE

WEIGHT : 2.0 kg

O.DIMENSION :

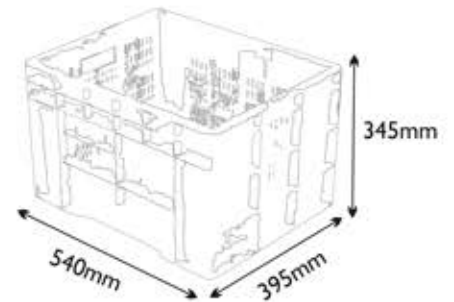

I.DIMENSION :

510mm x 363mm x 330mm



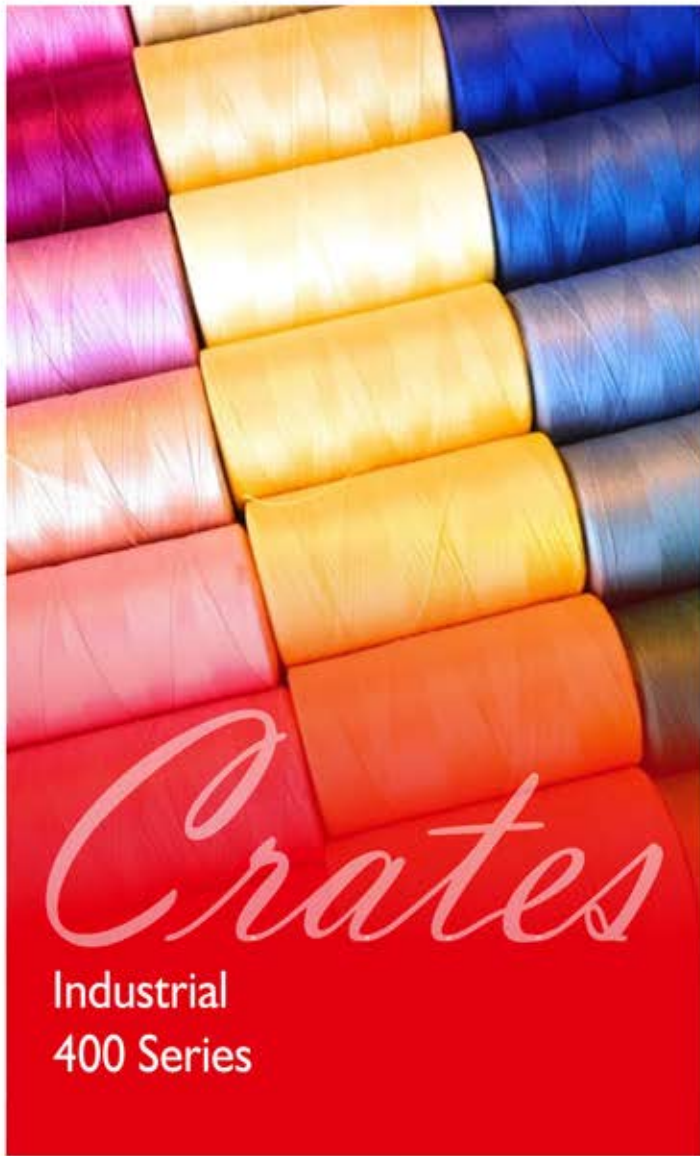

# Crates

Industrial  
400 Series



- MODEL NO : 4030065
- WEIGHT : 550 gm
- O.DIMENSION :

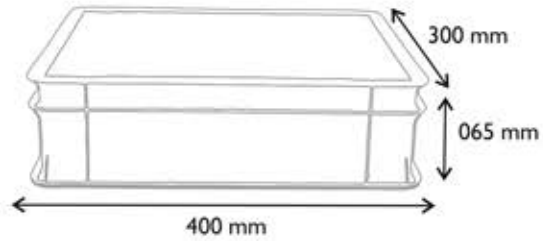

I.DIMENSION : 360mm x 260mm x 055mm



- MODEL NO : 4030120
- WEIGHT : 830 gm
- O.DIMENSION :



I.DIMENSION :  
360mm x 260mm x 110mm



- MODEL NO : 4030150
- WEIGHT : 950 gm
- O.DIMENSION :

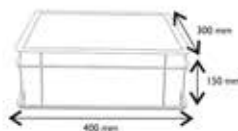

I.DIMENSION :  
360mm x 260mm x 140mm



- MODEL NO : 4030220
- WEIGHT : 1.280 kg
- O.DIMENSION :

I.DIMENSION :  
360mm x 260mm x 210mm  
Lid (top Cover To Close Crate)

Option Is Available.





MODEL NO : 5032100

WEIGHT : 1 kg

O.DIMENSION :

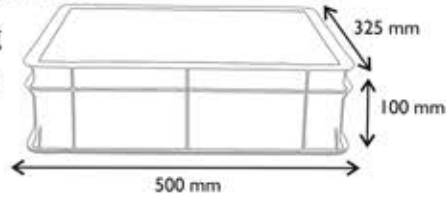

I.DIMENSION : 465mm x 290mm x 90mm



MODEL NO : 5032150

WEIGHT : 1.2 kg

O.DIMENSION :

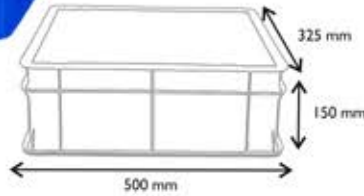

I.DIMENSION : 465mm x 290mm x 140mm



MODEL NO : 5032200

WEIGHT : 1.4 kg

O.DIMENSION :



I.DIMENSION :  
465mm x 290mm x 190mm



MODEL NO : 5032200  
Side Perforated

WEIGHT : 1.2kg

O.DIMENSION :

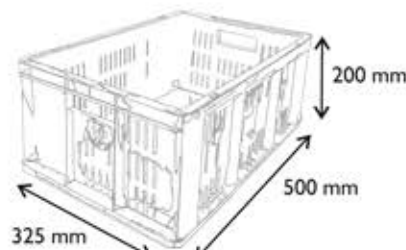

I.DIMENSION : 465mm x 290mm x 190mm  
WITH SIDE PERFORATED



MODEL NO : 5032250

WEIGHT : 1.65kg

O.DIMENSION :



I.DIMENSION :  
465mm x 290mm x 240mm





- ⊕ MODEL NO : 6040120 side Perforated
- ⊕ WEIGHT : 1.290 kg
- ⊕ O.DIMENSION :
- I.DIMENSION : 565mm x 370mm x 115mm

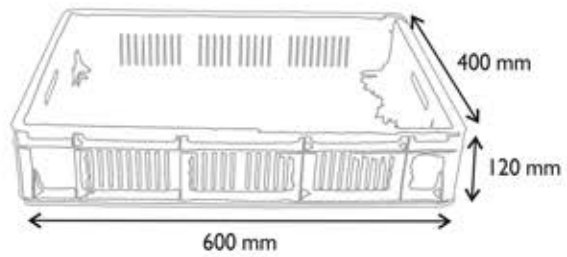

Lid (top Cover To Close Crate)  
Option Is Available.



- ⊕ MODEL NO : 6040120
- ⊕ WEIGHT : 1.410 kg
- ⊕ O.DIMENSION :
- I.DIMENSION : 565mm x 370mm x 115mm

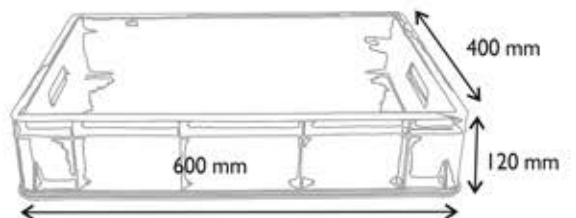

Lid (top Cover To Close Crate)  
Option Is Available.







- MODEL NO : 6040180
- ▲ WEIGHT : 1.6 kg
- O.DIMENSION :

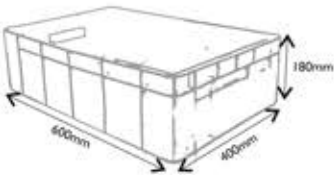

I.DIMENSION :  
565mm x 365mm x 170mm  
Lid (top Cover To Close Crate) Option Is Available.



- MODEL NO : 6040220 side Perforated
- ▲ WEIGHT : 1.860 kg
- O.DIMENSION :

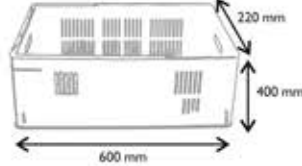

I.DIMENSION :  
565mm x 370mm x 210mm  
Lid (top Cover To Close Crate)  
Option Is Available.



- MODEL NO : 6040220
- ▲ WEIGHT : 2.280 kg
- O.DIMENSION :

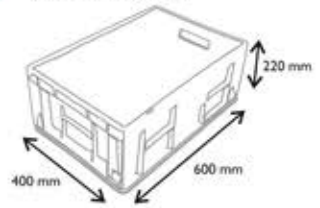

I.DIMENSION :  
565mm x 370mm x 210mm  
Lid (top Cover To Close Crate) Option Is Available.



- MODEL NO : 6040320
- ▲ WEIGHT : 2.4 kg
- O.DIMENSION :

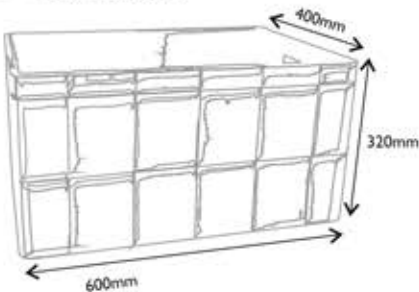

I.DIMENSION : 565mm x 365mm x 315mm  
Lid (top Cover To Close Crate)Option Is Available.



- MODEL NO : 6042300
- ▲ WEIGHT : 1.95 kg
- O.DIMENSION :

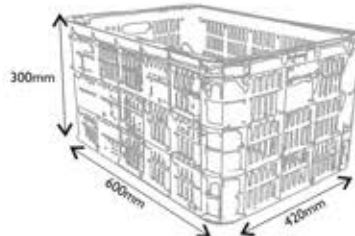

I.DIMENSION :  
565mm x 405mm x 260mm



- MODEL NO : 6545320
- ▲ WEIGHT : 3.2 kg
- O.DIMENSION :



I.DIMENSION :  
610mm x 410mm x 315mm  
Lid (top Cover To Close Crate)  
Option Is Available.





Industrial  
800 Series

## SUPER JUMBO

- MODEL NO : 8057425
- WEIGHT : 5.8 kg
- O.DIMENSION : 809mm x 570mm x 425mm

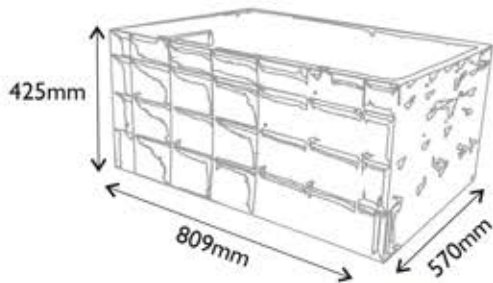

I.DIMENSION :  
760mm x 538mm x 405mm

Lid (top Cover To Close Crate)  
Option Is Available.



# Crate Fabricated

• TAILOR MADE PARTITIONS CAN BE MADE ACCORDING TO YOUR SPECIFICATIONS •

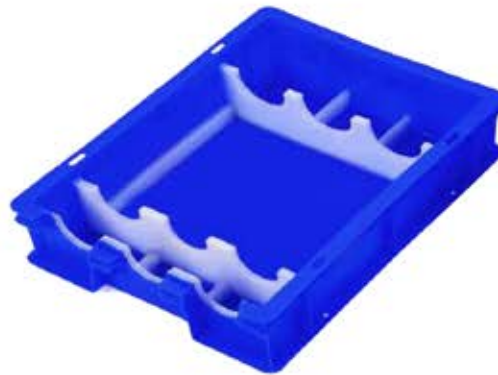

Transparent  
Crate



Long Crate

• TRANSPARENT & CONDUCTIVE CRATES AVAILABLE IN ANY MODEL ON DEMAND •





MODEL NO : BIN 15N, CRATE 25, CRATE 35, CRATE 45 & CRATE 50

DIMENSION :

MODEL NO.	DIMENSION
Bin 15N	185mm x 114mm x 78mm
Crate 25	225mm x 150mm x 125mm
Crate 35	295mm x 210mm x 160mm
Crate 45	350mm x 215mm x 200mm
Crate 50	515mm x 310mm x 200mm

Crate 50



Crate 35



Crate 25



Crate 45

Bin 15N





# Dairy *Crates*



- MODEL NO : 4737158
- WEIGHT : 1.5 kg
- O.DIMENSION :

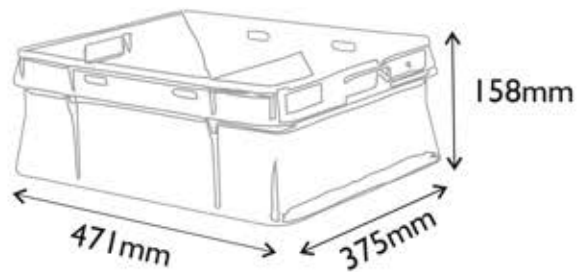

I.DIMENSION :  
427mm x 335mm x 147mm



# Pallets

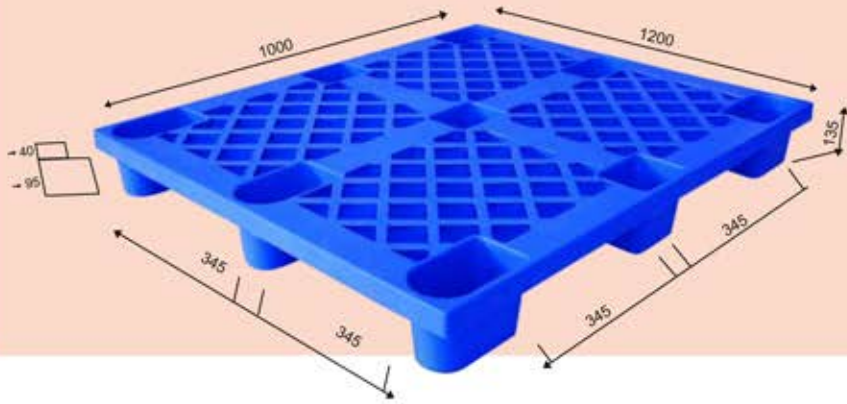

Front



Back



## VIP-008

SKID OPTION ALSO AVAILABLE (EXPORT PURPOSE)

Material : HDPE/PP	Dyanamic : Upto 1000 kg Unified Load (with wrapping)
Dimension : 1200 x 1000 x 135 mm	Racking : N.A
Static : 2000 kg Unified Load	Top Surface : Perforated 9 Legs
Weight : 7 kg	



Back

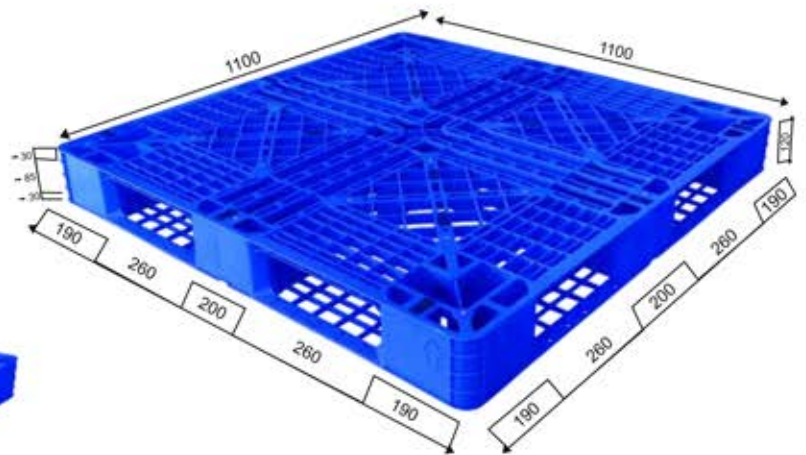

Front

## VIP-011

EXPORT PURPOSE

Material : HDPE/PP	Dyanamic : Upto 1000 kg Unified Load (with wrapping)
Dimension : 1100 x 1100 x 120 mm	Racking : N.A
Static : 2000 kg Unified Load	Top Surface : Perforated 6 Runner
Weight : 7.5 kg	



# Pallets

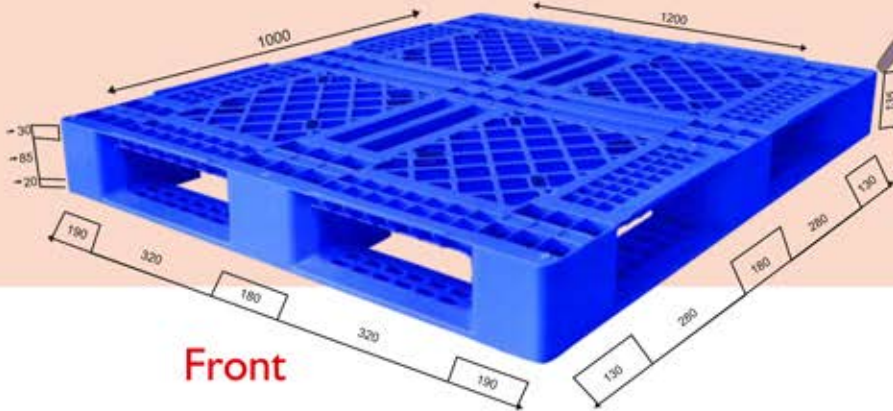

Front



Back



## VIP-010

Material : HDPE/PP	Dyanamic : Upto 1000 kg Unified Load
Dimension : 1200 x 1000 x 135 mm	Racking : Upto 400 kg Unified Load
Static : 2000 kg Unified Load	Top Surface : Perforated 6 Runner
Weight : 11 kg	

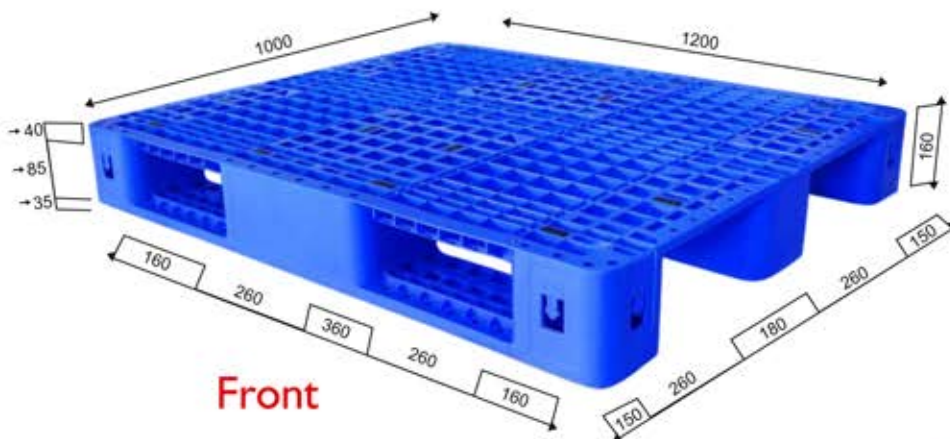

Front



Back

## VIP-004

Material : HDPE/PP	Dyanamic : Upto 750 kg Unified Load
Dimension : 1200 x 1000 x 160 mm	Racking : Upto 500 kg Unified Load
Static : 3000 kg Unified Load	Top Surface : Perforated 3 Runner
Weight : 14 kg	







# Pallets



Back

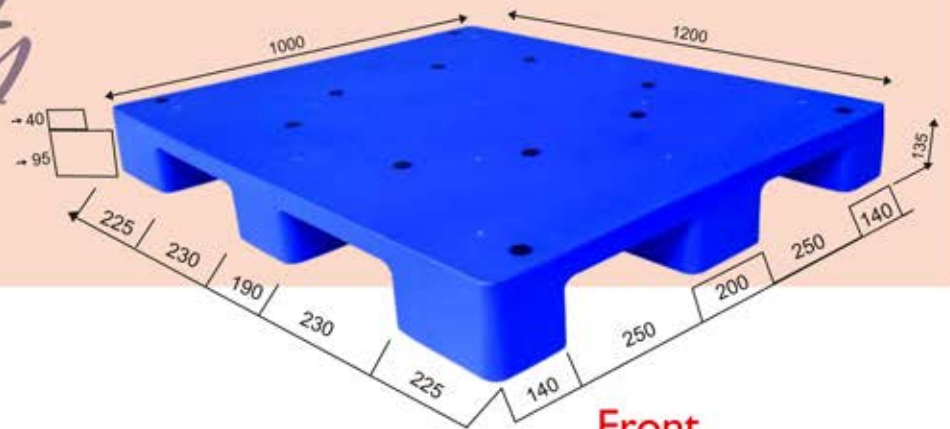

Front



## VIP-007

Material : HDPE/PP	Dyanamic : Upto 750 kg Unified Load
Dimension : 1200 x 1000 x 135 mm	Racking : N.A
Static : 2500 kg Unified Load	Top Surface : Plain Top 9 Legs
Weight : 13 kg	

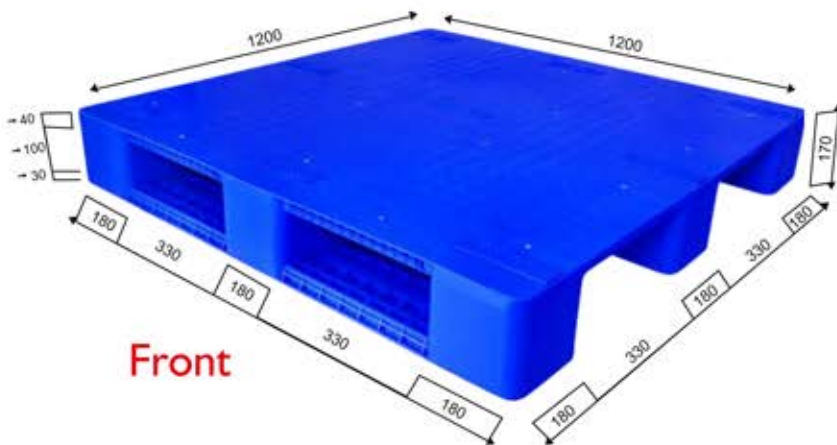

Front



Back

## VIP-006

Material : HDPE/PP	Dyanamic : Upto 1000 kg Unified Load
Dimension : 1200 x 1200 x 170 mm	Racking : Upto 1000 kg Unified Load
Static : 4000 kg Unified Load	Top Surface : Plain Top 3 Runner
Weight : 21 kg	





**NEW  
PRODUCT**

 CAPACITY : 25 Ltr. Waste Bin, 40 Ltr. Waste Bin



[vipplastics.in](http://vipplastics.in)

# Dustbins



🗑️ CAPACITY : 60 Ltr. Waste Bin, 80 Ltr. Waste Bin  
110 Ltr. Waste Bin & 120 Ltr. Waste Bin

📏 DIMENSION :

CAPACITY	DIMENSION
60 Ltr.	900 mm x 360 mm
80 Ltr.	900 mm x 430 mm
110 Ltr.	940 mm x 500 mm
120 Ltr.	980 mm x 490 mm

🗑️ CAPACITY : 120 Ltr.

📏 DIMENSION :

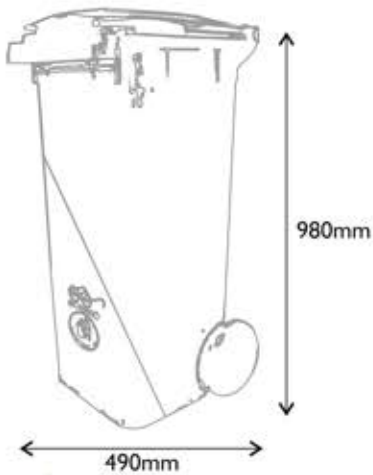

## VIP PLASTICS

Plot No. 368 & 369, Sector - 56, Phase - V, HSIIDC,  
Kundli, Haryana- 131028

+91-9999009090, +91-9999997797

care@vipplastics.in | vipplastics.in

     /vipplastics

